

DE	Montageanleitung	2
FR	Instructions de montage	2
EN	assembly instructions	3
IT	Istruzioni per Installazione	3
ES	Instrucciones de montaje	4
NL	Handleiding	4
DK	Monteringsvejledning	5
PT	Manual de Instalação	5
PL	Instrukcja montażu	6
CS	Montážní návod	6
SK	Montážny návod	7
ZH	组装说明	7
RU	Инструкция по монтажу	8
HU	Szerelési útmutató	8
FI	Asennusohje	9
SV	Monteringsanvisning	9
LT	Montavimo instrukcijos	10
HR	Uputstva za instalaciju	10
TR	Montaj kılavuzu	11
RO	Instrucțiuni de montare	11
EL	Οδηγία συναρμολόγησης	12
SL	Navodila za montažo	12
ET	Paigaldusjuhend	13
LV	Montāžas instrukcija	13
SR	Uputstvo za montažu	14
NO	Montasjeveiledning	14
BG	Инструкция за употреба	15
SQ	Udhëzime rreth montimit	15
AR	تعليمات التجميع	16

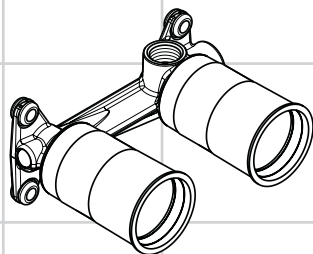

13622180



Sicherheitshinweise

- ⚠ Bei der Montage müssen zur Vermeidung von Quetsch- und Schnittverletzungen Handschuhe getragen werden.
- ⚠ Große Druckunterschiede zwischen den Kalt- und Warmwasseranschlüssen müssen ausgeglichen werden.

Montagehinweise

Achtung! Die Armatur muss nach den gültigen Normen montiert, gespült und geprüft werden.

Symbolerklärung



Kein essigsäurehaltiges Silikon verwenden!



Endmontage (siehe Seite 19)



Maße (siehe Seite 17)



Serviceteile (siehe Seite 32)



Prüfzeichen (siehe Seite 32)



Consignes de sécurité

- ⚠ Lors du montage, porter des gants de protection pour éviter toute blessure par écrasement ou coupure.
- ⚠ Il est conseillé d'équilibrer les pressions de l'eau chaude et froide.

Instructions pour le montage

Attention! La robinetterie doit être installée, rincée et contrôlée conformément aux normes valables.

Description du symbole



Ne pas utiliser de silicone contenant de l'acide acétique!



Finition (voir page 19)



Dimensions (voir page 17)



Pièces détachées (voir page 32)



Classification acoustique et débit (voir page 32)



**Montage siehe
Seite 18**



**Montage voir page
18**



Safety Notes

-  Gloves should be worn during installation to prevent crushing and cutting injuries.
-  The hot and cold supplies must be of equal pressures.

Installation Instructions

Important! The fitting must be installed, flushed and tested after the valid norms.

Symbol description



Do not use silicone containing acetic acid!



Final assembly (see page 19)



Dimensions (see page 17)





Spare parts (see page 32)



Test certificate (see page 32)

Indicazioni sulla sicurezza

-  Durante il montaggio, per evitare ferite da schiacciamento e da taglio bisogna indossare guanti protettivi.
-  **Attenzione!** Compensare le differenze di pressione tra i collegamenti dell'acqua fredda e dell'acqua calda.

Istruzioni per il montaggio

Attenzione! La rubinetteria deve essere installata, pulita e testata secondo le istruzioni riportate!

Descrizione simbolo



Non utilizzare silicone contenente acido acetico!



Montaggio finale (vedi pagg. 19)



Ingombri (vedi pagg. 17)



Parti di ricambio (vedi pagg. 32)



Segno di verifica (vedi pagg. 32)

**Assembly see page
18**



**Montaggio vedi
pagg. 18**



Indicaciones de seguridad

- ⚠ Durante el montaje deben utilizarse guantes para evitar heridas por aplastamiento o corte.
- ⚠ Grandes diferencias de presión en servicio entre agua fría y agua caliente deben equilibrarse.

Indicaciones para el montaje

¡ATENCIÓN! El grifo tiene que ser instalado, probado y testado, según las normas en vigor.

Descripción de símbolos



No utilizar silicona que contiene ácido acético!



Montaje final (ver página 19)



Dimensiones (ver página 17)



Repuestos (ver página 32)



Marca de verificación (ver página 32)



Veiligheidsinstructies

- ⚠ Bij de montage moeten ter voorkoming van knel- en snijwonden handschoenen worden gedragen.
- ⚠ Grote drukverschillen tussen de koud- en warmwatertoevoer dienen vermeden te worden.

Montage-instructies

Attentie! Leidingen doorspoelen volgens Norm. De mengkraan vervolgens monteren en controleren.

Symboolbeschrijving



Gebruik geen zuurhoudende silicone!



Afmontage (zie blz. 19)



Maten (zie blz. 17)



Service onderdelen (zie blz. 32)



Keurmerk (zie blz. 32)



**Montaje ver
página 18**



**Montage zie blz.
18**



 **Sikkerhedsanvisninger**

-  Ved monteringen skal der bruges handsker for at undgå kvæstelser og snitsår.
-  Større trykforskelle mellem koldt og varmt vand bør udjævnes.

Monteringsanvisninger

Advarsel! Ifølge gældende regler, skal armaturet monteres, skylles igennem og afprøves.

Symbolbeskrivelse



Der må ikke benyttes eddikesyreholdig silikone!



Slutmontering (se s. 19)



Målene (se s. 17)





Reserve dele (se s. 32)



Godkendelse (se s. 32)

 **Avisos de segurança**

-  Durante a montagem devem ser utilizadas luvas de protecção, de modo a evitar ferimentos resultantes de entalamentos e de cortes.
-  Grandes diferenças entre as pressões das águas quente e fria devem ser compensadas.

Avisos de montagem

Atenção! A misturadora deve ser instalada, purgada e testada de acordo com as normas em vigor.

Descrição do símbolo



Não utilizar silicone que contenha ácido acético!



Acabamento Fina (ver página 19)



Medidas (ver página 17)



Pecas de substituição (ver página 32)



Marca de controlo (ver página 32)

Montering se s. 18



Montagem ver página 18



Wskazówki bezpieczeństwa

- △ Aby uniknąć zranień, takich jak zgniecenia czy przecięcia, podczas montażu należy nosić rękawice.
- △ Znaczne różnice ciśnień na doptywach cieplej i zimnej wody muszą zostać wyrównane.

Wskazówki montażowe

Uwaga! Armatura musi być zamontowana, przepłukana i wypróbowana według obowiązujących norm.

Opis symbolu



Nie stosować silikonów zawierających kwas octowy!



Montaż końcowy (patrz strona 19)



Wymiary (patrz strona 17)



Części serwisowe (patrz strona 32)



Znak jakości (patrz strona 32)

Bezpečnostní pokyny

- △ Pro zabránění řezným zraněním a pohmožděním je nutné při montáži nosit rukavice.
- △ Je nutné vyrovnat velké rozdíly tlaku mezi přípoji studené a teplé vody.

Pokyny k montáži

Pozor! Armatura se musí montovat, proplachovat a testovat podle platných norem.

Popis symbolů



Nepoužívat silikon s obsahem kyseliny octové!



Konečná montáž (viz strona 19)



Rozměry (viz strona 17)



Servisní díly (viz strona 32)



Zkušební značka (viz strona 32)

**Montaż patrz
strona 18**



**Montáž viz strona
18**



Bezpečnostné pokyny

- △ Pri montáži musíte nosiť rukavice, aby ste predišli pomliaždeninám a rezným poraneniam.
- △ Veľké rozdiely v tlaku medzi prípojkami studenej a teplej vody musia byť vyrovnané.

Pokyny pre montáž

Pozor! Armatúra sa musí montovať, preplachovať a testovať podľa platných noriem.

Popis symbolov



Nepoužívať silikón s obsahom kyseliny octovej!



Konečná montáž (viď strana 19)



Rozmery (viď strana 17)



Servisné diely (viď strana 32)



Osvedčenie o skúške (viď strana 32)

安全技巧

- △ 装配时为避免挤压和切割受伤，必须戴上手套。
- △ 冷热水管间过大的压力差必须予以平衡。

安装提示

注意! 必须按照现行的规定安装，冲洗和测试产品。

符号说明



请勿使用含有乙酸的硅!



总装配 (参见第 19 页)



大小 (参见第 17 页)



备用零件 (参见第 32 页)



检验标记 (参见第 32 页)

**Montáž vid' strana
18**



安装 参见第 18 页



Указания по технике

безопасности

- △ Во время монтажа следует надеть перчатки во избежание прищемления и порезов.
- △ донного клапа. Перед установкой смесителя необходимо регулировочными кранами выровнять авление холодной и горячей воды при помощи вентмлей регулирующих подачу воды в квартиру.

Указания по монтажу

Внимание! Смеситель должен быть смонтирован по действующим нормам и в соответствии с настоящей инструкцией, проверен на геметичность и безупречность работы.

Описание символов



Не применяйте силикон, содержащий уксусную кислоту.



Окончательная сборка (см. стр. 19)



Размеры (см. стр. 17)



Комплект (см. стр. 32)



Знак технического контроля (см. стр. 32)



Biztonsági utasítások

- △ A szerelésnél a zúzódások és vágási sérülések elkerülése érdekében kesztyűt kell viselni.
- △ A hidegvíz- és a melegvíz-csatlakozások közötti nagy nyomáskülönbséget kikell egyenlíteni!

Szerelési utasítások

Figyelem! A csaptelepet az érvényben lévő előírásoknak megfelelően kell felszerelni, átöblíteni és ellenőrizni.

Szimbólumok leírása



Ne használjon ecetsavtartalmú szilikont!



Beépített, kész szerelvény (lásd a 19. oldalon)



Méretet (lásd a 17. oldalon)



Tartozékok (lásd a 32. oldalon)



Vizsgajel (lásd a 32. oldalon)

Монтаж см. стр. 18



Szerelés lásd a 18. oldalon



Turvallisuusohjeet

- △ Asennuksessa on käytettävä käsiineitä puristumien ja viiltojen aiheuttamien tapaturmien estämiseksi.
- △ Suuret paine-erot kylmä- ja kuumavesiliitännöiden välillä on tasattava.

Asennusohjeet

Huomio! Kaluste on asennettava, huuhdeltava ja tarkastettava voimassa olevien määräysten mukaisesti.

Merkin kuvaus



Älä käytä etikkahappopitoista silikonia!



Loppuasennus (katso sivu 19)



Mitat (katso sivu 17)



Varaosat (katso sivu 32)



Koestusmerkki (katso sivu 32)

Säkerhetsanvisningar

- △ Handskar ska bäras under monteringsarbetet så att man kan undvika kläm- och skärskadorgen werden.
- △ Stora tryckskillnader mellan anslutningarna för varmt och kallt vatten måste utjämnas.

Monteringsanvisningar

OBS! Armaturen måste installeras, genomspolas och testas enligt gällande föreskrifter.

Simbolio aprašymas



Använd inte silikon som innehåller ättiksyra!



Slutmontering (se sidan 19)



Måtten (se sidan 17)



Reservdelar (se sidan 32)



Testsigill (se sidan 32)

**Asennus katso sivu
18**



**Montering se sidan
18**



Saugumo technikos nurodymai

- ⚠️ Apsaugai nuo užspaudimo ir įsijovimo montavimo metu dėvėkite pirštines.
- ⚠️ Turi būti išlyginti šalto ir karšto slėgio nelygumai.



Sigurnosne upute

- ⚠️ Prilikom montaže se radi sprječavanja prignječenja i posjekotina moraju nositi rukavice.
- ⚠️ Velika razlika u pritisku između vruće i hladne vode mora biti izbalansirana.

Montavimo instrukcija

Dėmesio! Maišytuvas privalo būti montuojamas ir išbandomas pagal veikiančias normas ir šią instrukciją.

Simbolio aprašymas



Nenaudokite silikono, kurio sudėtyje yra acto rūgšties!



Galutinis montavimas (žr. psl. 19)



Išmatavimai (žr. psl. 17)



Atsarginės dalys (žr. psl. 32)



Bandymo pažyma (žr. psl. 32)

Upute za montažu

Pažnja! Cijevi moraju biti postavljene, isprane i testirane prema važećim normama.

Opis simbola



Nemojte koristiti silikon koji sadrži octenu kiselinu!



Završna montaža (pogledaj stranicu 19)



Mjere (pogledaj stranicu 17)



Rezervni djelovi (pogledaj stranicu 32)



Oznaka testiranja (pogledaj stranicu 32)

**Montavimas žr.
psl. 18**



**Sastavljanje
pogledaj stranicu 18**



⚠ Güvenlik uyarıları

- ⚠ Montaj esnasında ezilme ve kesilme gibi yaralanmaları önlemek için eldiven kullanılmalıdır.
- ⚠ Sıcak ve soğuk su bağlantıları arasında büyük basınç farklılıkları varsa, bu basınç farklılıklarının dengelenmesi gerekir.

Montaj açıklamaları

Önemli! Batarya monte edilmeli, geçerli normlardan sonra akis testi yapılmalıdır.

Simge açıklaması



Asetik asit içeren silikon kullanmayın!



Son Uygulama (Bakınız sayfa 19)



Ölçüleri (Bakınız sayfa 17)



Yedek Parçalar (Bakınız sayfa 32)



Kontrol işareti (Bakınız sayfa 32)

⚠ Instrucțiuni de siguranță

- ⚠ La montare utilizați mănuși pentru evitarea contuziunilor și tăierii mâinilor.
- ⚠ Diferențele de presiune mari între alimentarea cu apă rece și apă caldă trebuie echilibrate.

Instrucțiuni de montare

Atenție! Bateria trebuie montată, clătită și verificată conform normelor în vigoare.

Descrierea simbolurilor



Nu utilizați silicon cu conținut de acid acetic!



Montare finală (vezi pag. 19)



Dimensiuni (vezi pag. 17)



Piese de schimb (vezi pag. 32)



Certificat de testare (vezi pag. 32)

**Montajı Bakınız
sayfa 18**



**Montare vezi pag.
18**



Υποδειξεις ασφαλείας

- ⚠ Για να αποφύγετε τραυματισμούς κατά τη συναρμολόγηση πρέπει να φοράτε γάντια.
- ⚠ Οι διαφορές της πίεσης μεταξύ της σύνδεσης κρύου και ζεστού νερού θα πρέπει να αντισταθμίζονται.



Varnostna opozorila

- ⚠ Pri montaži je treba nositi rokavice, da se preprečijo poškodbe zaradi zmečkanja ali urezov.
- ⚠ Velike razlike v tlaku med priključkom za mrzlo in priključkom za toplo vodo je potrebno izravnati.

Οδηγίες συναρμολόγησης

Προσοχή! Η μπαταρία πρέπει να τοποθετηθεί, να πλυθεί και να ελεγχθεί με βάση τους ισχύοντες κανόνες υδραυλικής τέχνης

Περιγραφή συμβόλων



Μην χρησιμοποιείτε σιλικόνη που περιέχει οξικό οξύ!



Τελική συναρμολόγηση (βλ. σελίδα 19)



Διαστάσεις (βλ. σελίδα 17)



Ανταλλακτικά (βλ. σελίδα 32)



Σήμα ελέγχου (βλ. σελίδα 32)

Navodila za montažo

Attention! La robinetterie doit être installée, rincée et contrôlée conformément aux normes valables.

Opis simbola



Ne smete uporabiti silikona, ki vsebuje ocetno kislino!



Κοńčna montaža (glejte stran 19)



Mere (glejte stran 17)



Rezervni deli (glejte stran 32)



Preskusni znak (glejte stran 32)



**Συναρμολόγηση
βλ. σελίδα 18**



**Montaža Glejte
stran 18.**



Ohutusjuhised

-  Kandke paigaldamisel muljumis- ja löikevigastuste vältimiseks kindaid.
-  Kui külma ja kuuma vee ühenduste surve on väga erinev, tuleb need tasakaalustada.

Paigaldamisjuhised

Tähelepanu! Seadmestiku paigaldamine, läbipesu ja kontrollimine peab toimuma vastavalt kehtivatele normidele.

Sümbolite kirjeldus



Ärge kasutage äädikhapet sisaldavat silikooni!



Lõplik paigaldus (vt lk 19)



Mõõtude (vt lk 17)





Varuosad (vt lk 32)



Kontrollsertifikaat (vt lk 32)

Drošības norādes

-  Montāžas laikā, lai izvairītos no saspiedumiem un iegriezumiem, nepieciešams nēsāt cimdus.
-  Jāizlīdzina spiediena atšķirības starp aukstā un karstā ūdens pievadiem.

Norādījumi montāžai

Uzmanību! Jaucējkrāns jāmontē, jāskalo un jāpārbauda atbilstoši spēkā esošajām normām.

Simbolu nozīme



Neizmantojiet silikonu, kas satur etiķskābi!



Beigu montāža (skat. 19. lpp.)



Izmērus (skat. 17. lpp.)



Rezerves daļas (skat. 32. lpp.)



Pārbaudes zīme (skat. 32. lpp.)

**Paigaldamine vt lk
18**



**Montāža skat. 18.
lpp.**



Sigurnosne napomene

- ⚠ Prilikom montaže se radi sprečavanja prignječenja i posekofina moraju nositi rukavice.
- ⚠ Velika razlika u pritisku između vruće i hladne vode mora biti izbalansirana.

Instrukcije za montažu

Pažnja! Armatura mora biti postavljena, isprana i testirana prema važećim normama.

Opis simbola



Nemojte koristiti silikon koji sadrži sircetnu kiselinu!



Završna montaža (vidi stranu 19)



Mere (vidi stranu 17)



Rezervni delovi (vidi stranu 32)



Ispitni znak (vidi stranu 32)



Sikkerhetshenvisninger

- ⚠ Bruk hansker under montasjen for å unngå klem- og kuttskader.
- ⚠ Store trykkdifferanser mellom kaldt- og varmtvannstilkoblinger skal utlignes.

Montagehenvisninger

Obs! Armaturen skal monteres, spyles og sjekkes iht. gyldige standarder.

Symbolbeskrivelse



Ikke bruk silikon som inneholder eddiksyre!



Sluttmontasje (se side 19)



Mål (se side 17)



Serviceleder (se side 32)



Prøvemerket (se side 32)



**Montaža vidi
stranu 18**



**Montasje se side
18**



Указания за безопасност

-  При монтажа трябва да се носят ръкавици, за да се избегнат наранявания поради притискане или порязване.
-  Големите разлики в налягането между изводите за студената и топлата вода трябва да се изравняват.

Указания за монтаж

Внимание! Арматурата трябва да се монтира, промие и провери в съответствие с валидните норми.

Описание на символите



Не използвайте силикон, съдържащ оцетна киселина!



Довършителен монтаж (вижте стр. 19)



Размери (вижте стр. 17)





Сервизни части (вижте стр. 32)



Контролен знак (вижте стр. 32)

Udhëzime sigurie

-  Për të evituar lëndimet e pickimeve ose të prerjeve gjatë procesit të montimit duhet që të vishni doreza.
-  Ndryshimet e mëdha të presionit mes lidhjeve të ujit të ftohtë dhe atij të ngrohtë duhen ekuilibruar.

Udhëzime për montimin

Kujdes! Armatura duhet montuar, shpërlarë dhe kontrolluar në bazë të normave të vlefshme.

Përshkrimi i simbolit



Mos përdorni silikon që në përbërje ka acid acetik.



Montimi përfundimtar (shih faqen 19)



Përmasat (shih faqen 17)



Pjesët e servisit (shih faqen 32)



Shenja e kontrollit (shih faqen 32)

**Монтаж вижте
стр. 18**



**Montimi shih faqen
18**



⚠️ تنبيهات الأمان

- ⚠️ يجب إرتداء قفازات للبرد أثناء التركيب لتجنب حدوث أخطار الإنحشار أو الجروح.
- ⚠️ يجب أن يكون تيار الماء الساخن والماء البارد متعادلين في الضغط.

تعليمات التركيب

هام! يجب تركيب الوصلة واستخدامها واختبارها وفقاً للمعايير المعمول بها.

وصف الرمز

هام! لا تستخدم السليكون الذي يحتوي على أحماض!



التجميع النهائي (راجع صفحة 19)



أبعاد (راجع صفحة 17)

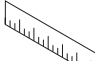

قطع الغيار (راجع صفحة 32)

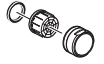

شهادة اختبار (راجع صفحة 32)



التركيب راجع صفحة 18

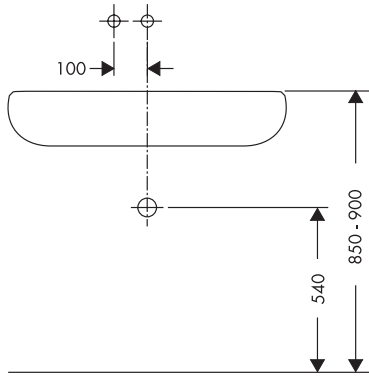
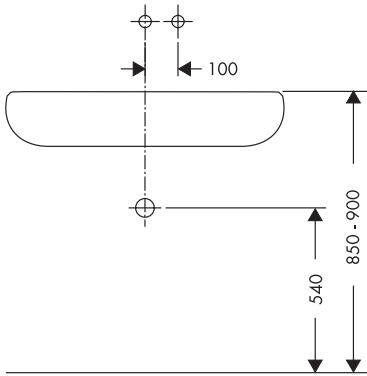
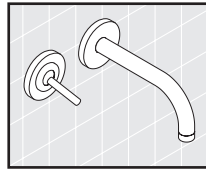
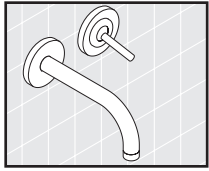
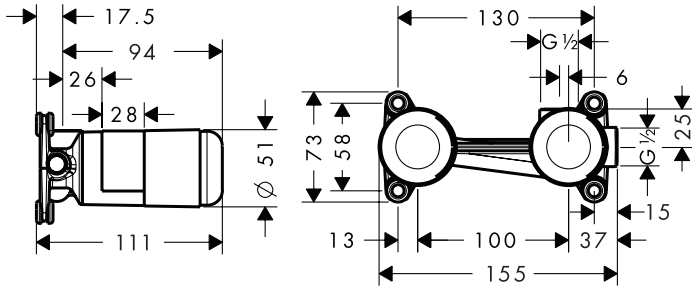

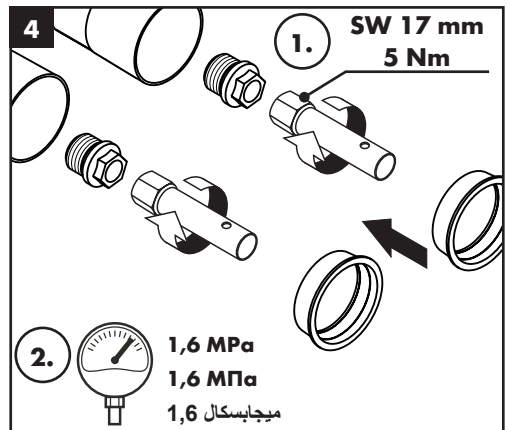
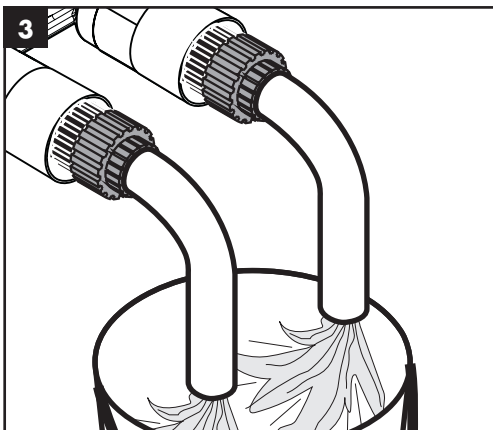
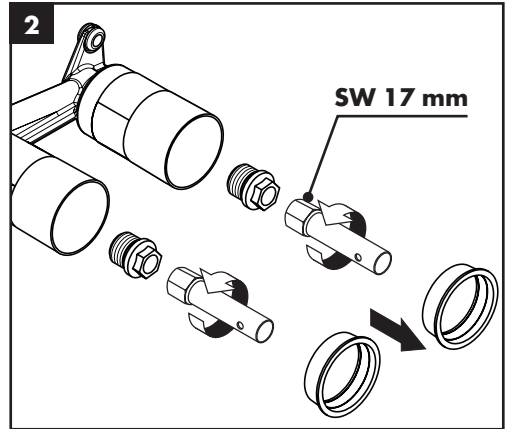
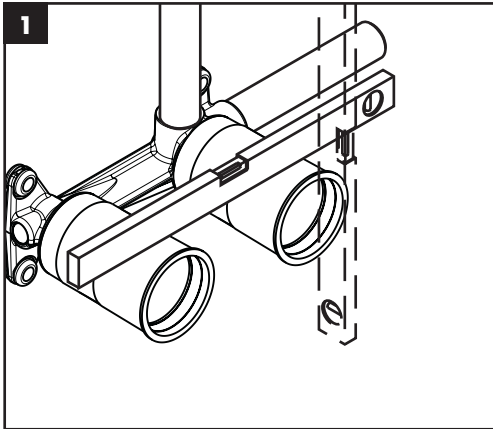
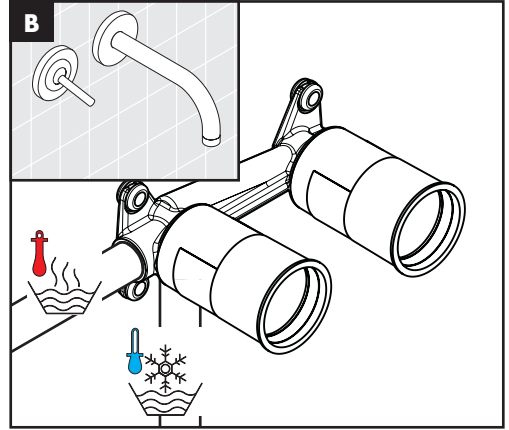
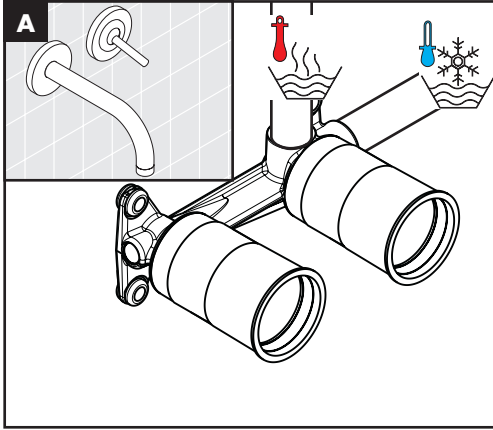

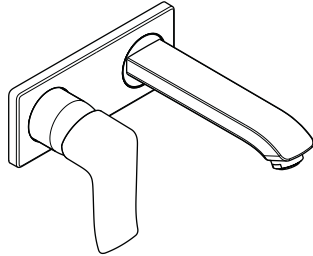
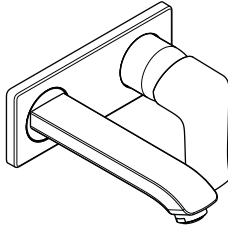

Metris 31085000

Metris 31086000

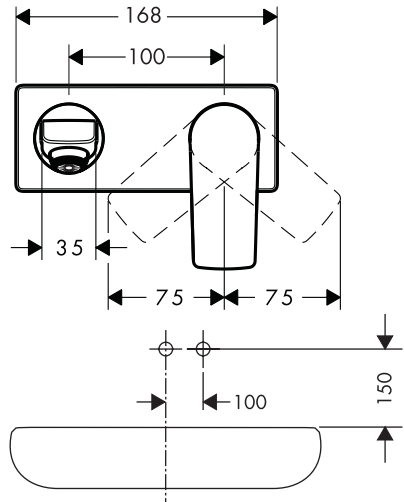
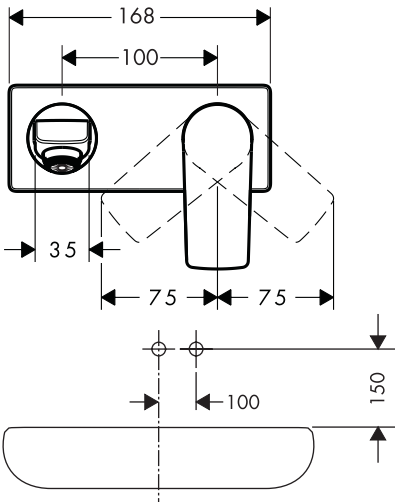
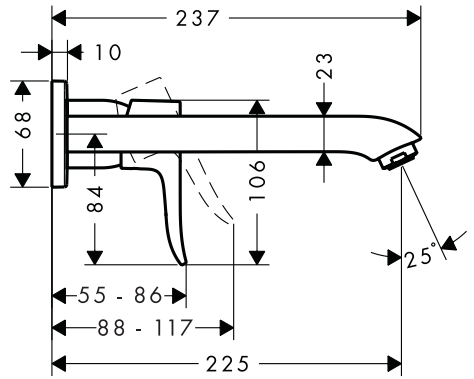
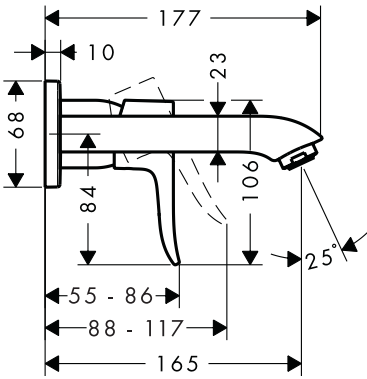

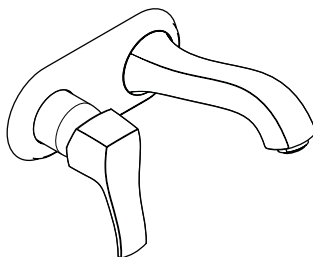
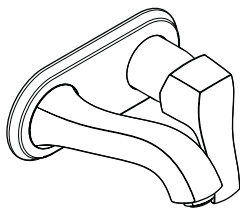

Metris Classic 31000XXX

Metris Classic 31003XXX

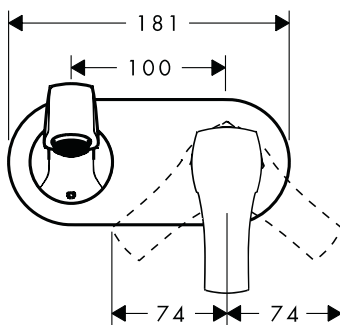
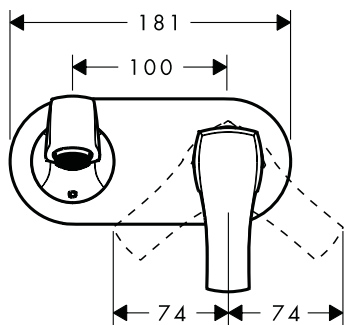
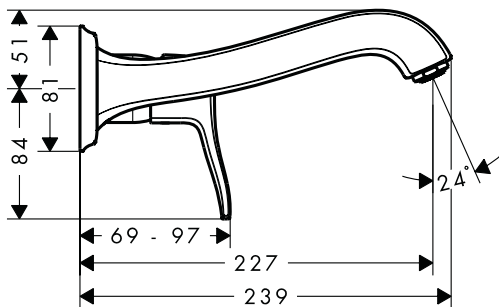
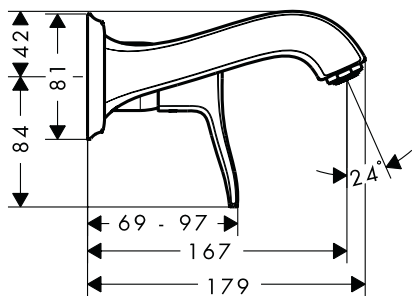

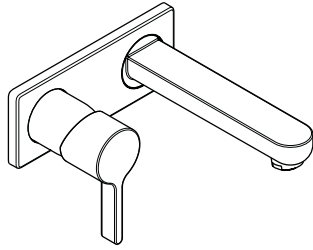
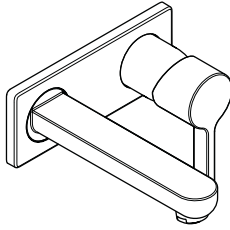

Metris S 31162000

Metris S 31163000

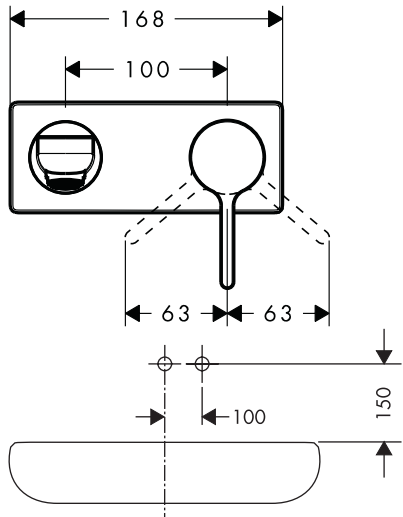
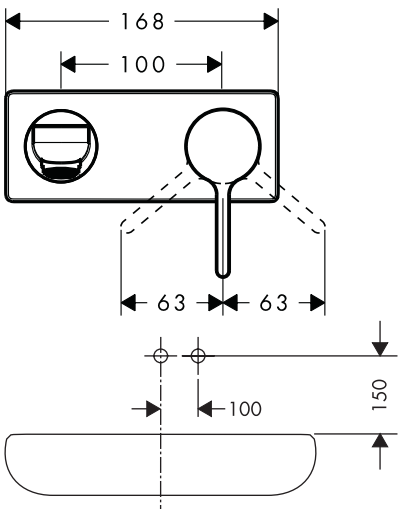
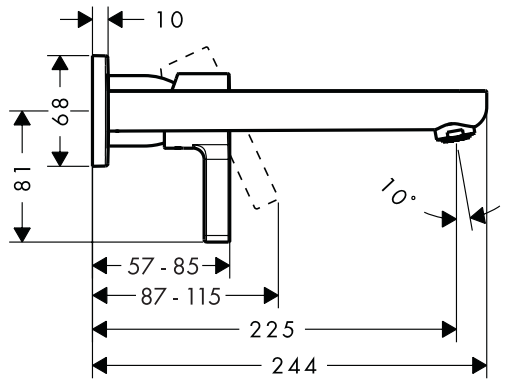
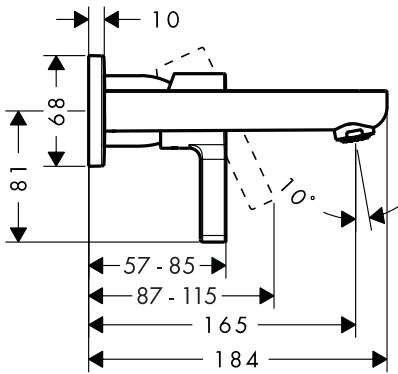

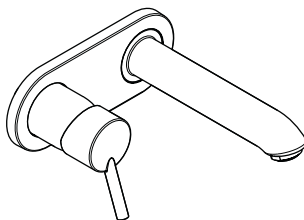
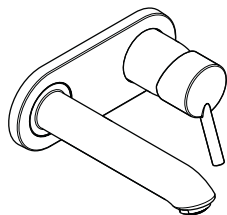

Talis S² 31618000

Talis S² 31611000

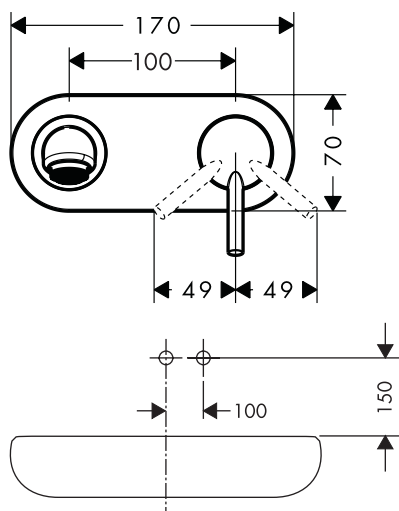
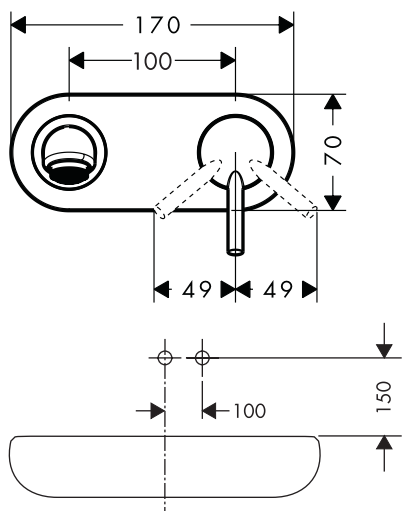
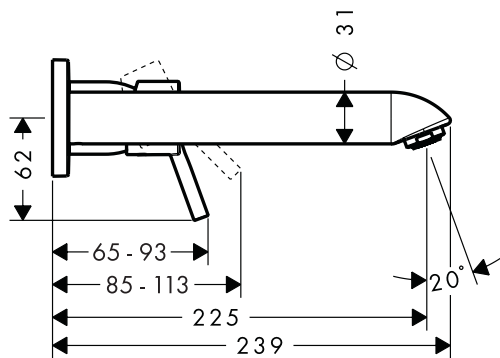
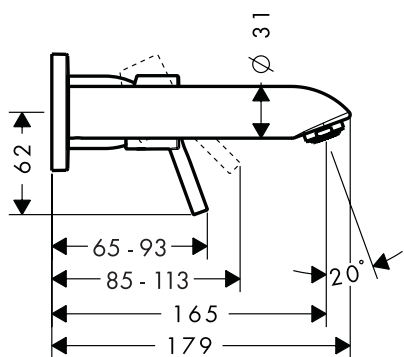

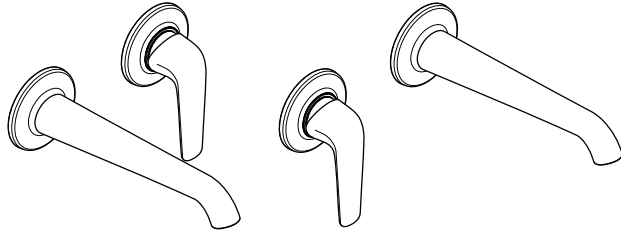

Bouroullec 19125000

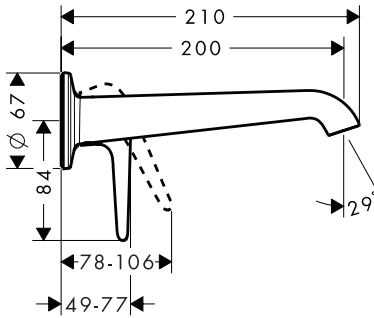

Bouroullec 19127000

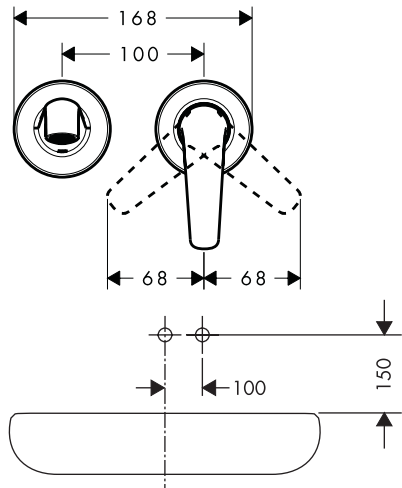
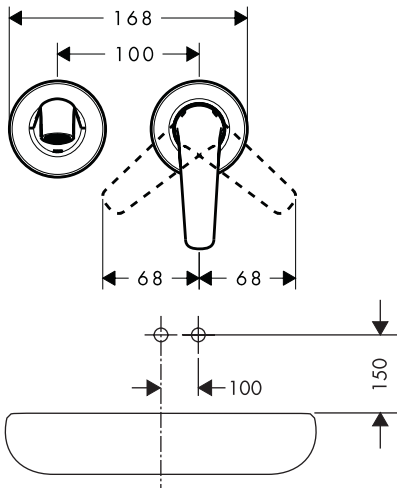
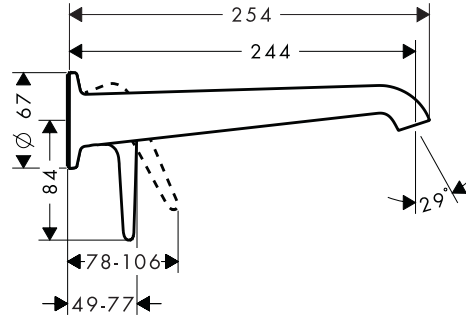

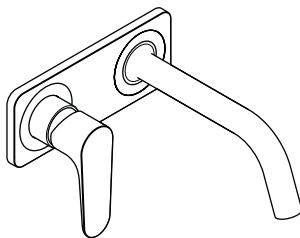
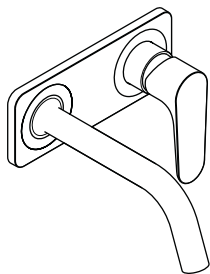

Citterio M 34112000

Citterio M 34115000

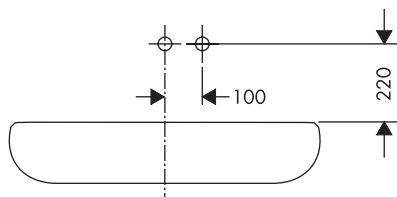
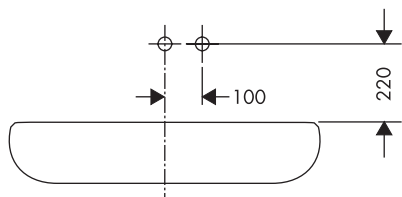
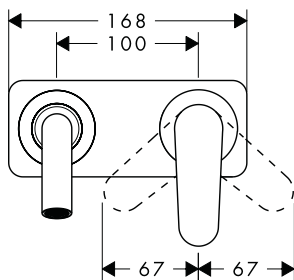
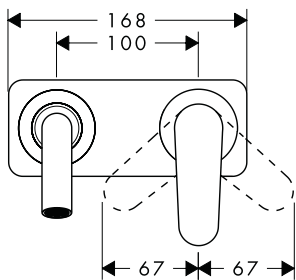
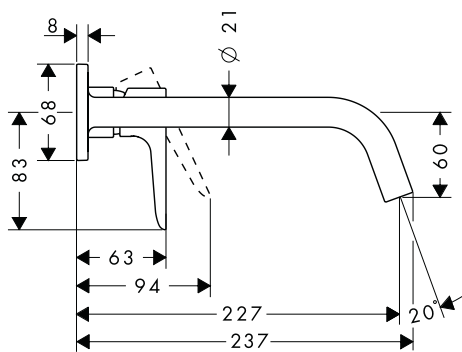
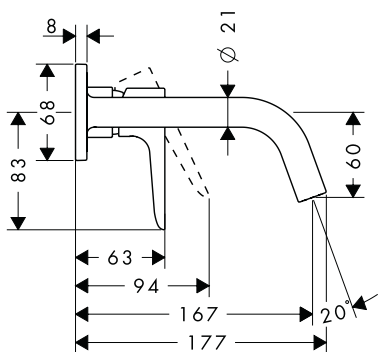

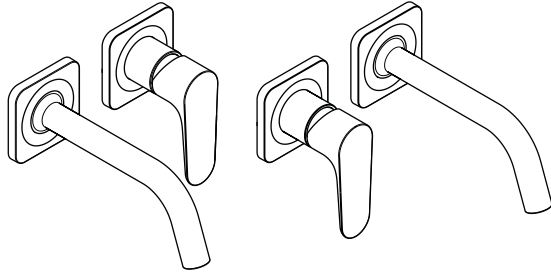

Citterio M 34113000

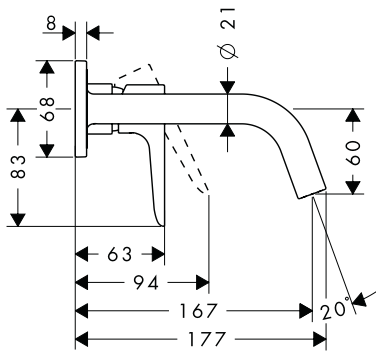

Citterio M 34116000

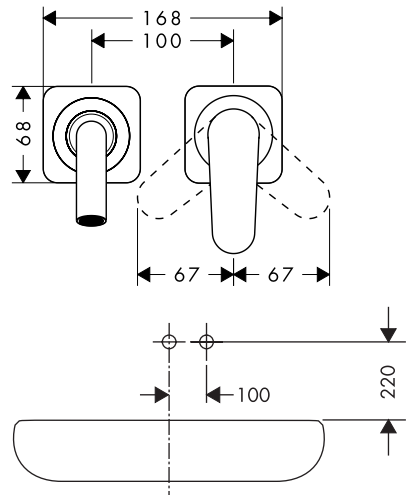
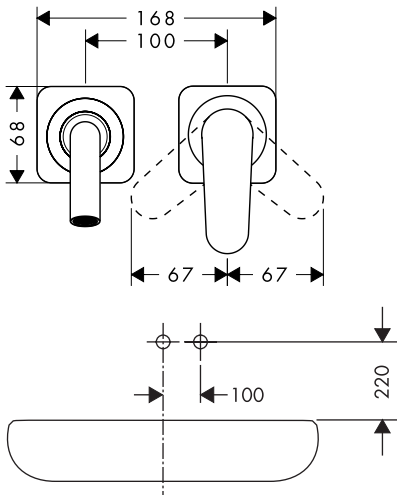
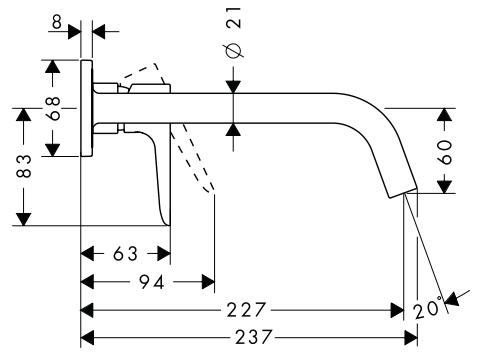

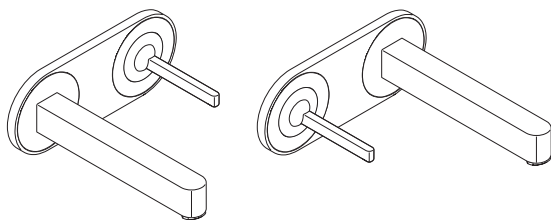

Steel 35112800

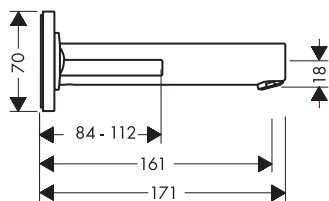

Steel 35115800

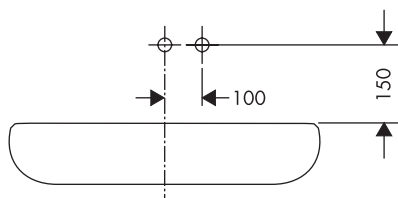
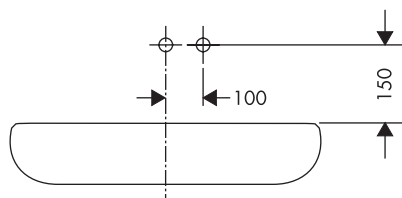
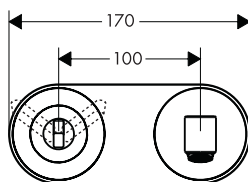
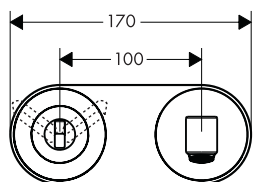

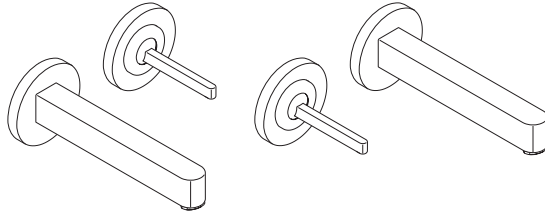

Steel 35113800

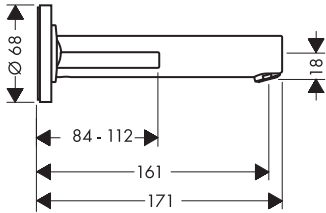

Steel 35116800

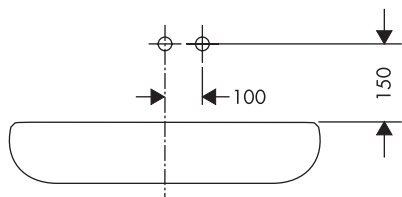
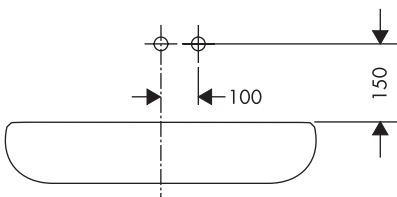
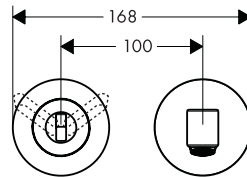
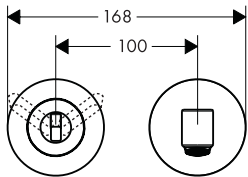
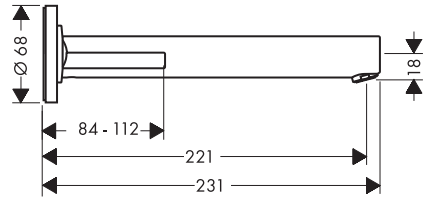

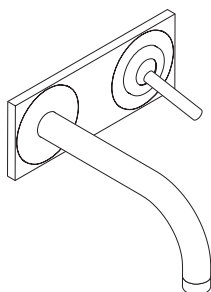

Uno 38112XXX

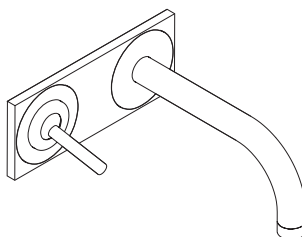

Uno 38115XXX

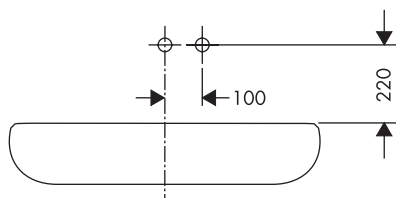
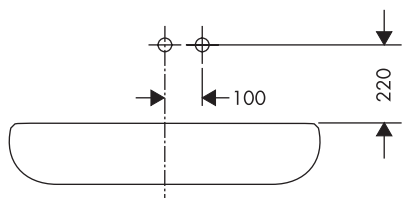
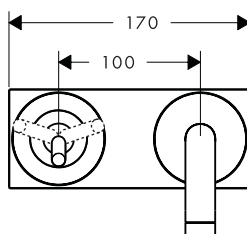
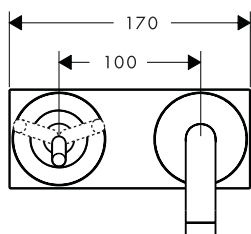
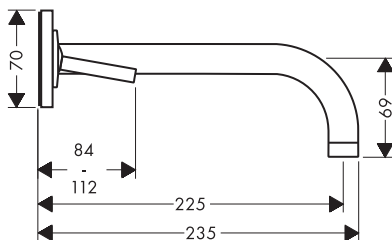
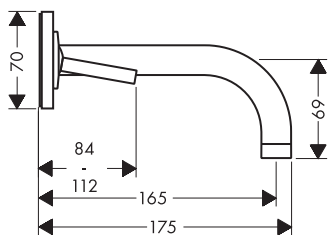

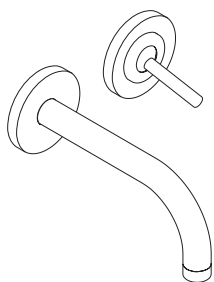

Uno 38113XXX

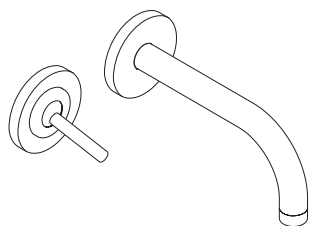

Uno 38116XXX

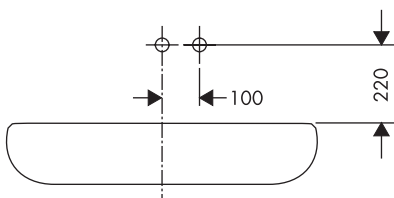
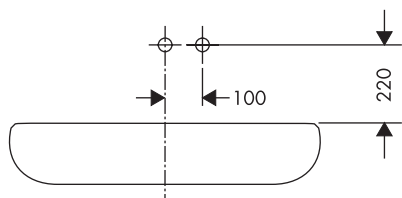
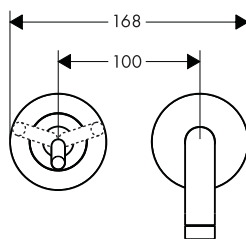
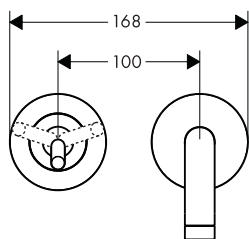
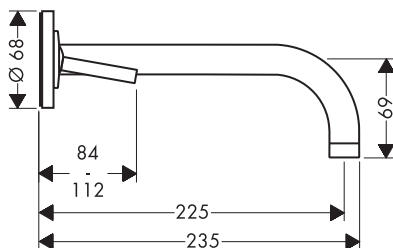
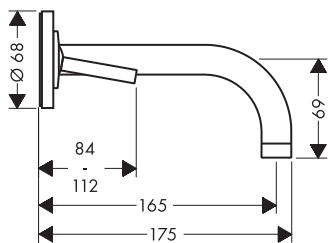

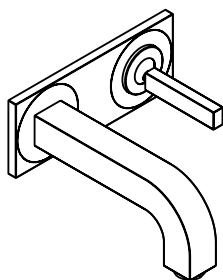

Citterio 39112XXX

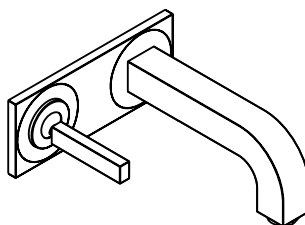

Citterio 39115XXX

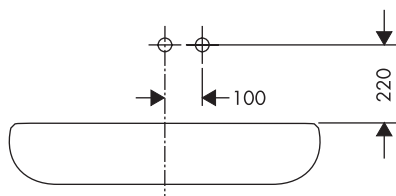
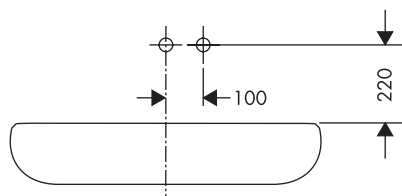
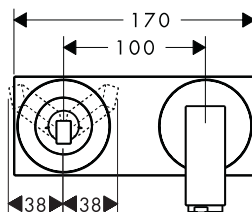
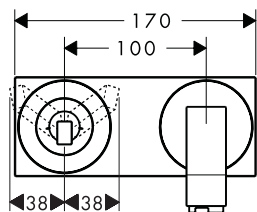
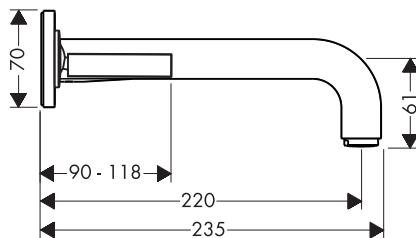
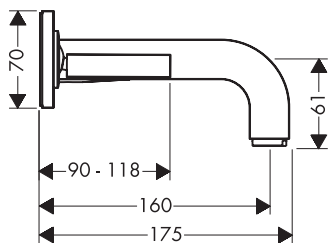

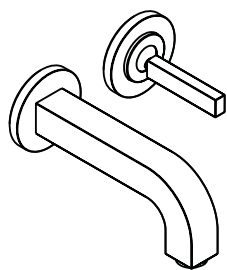

Citterio 39113XXX

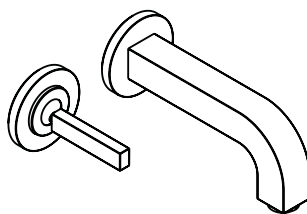

Citterio 39116XXX

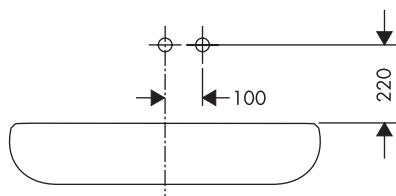
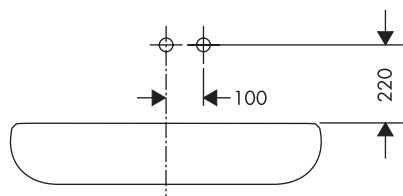
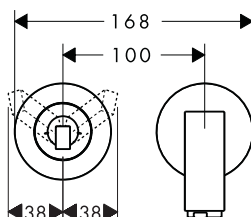
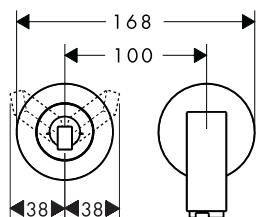
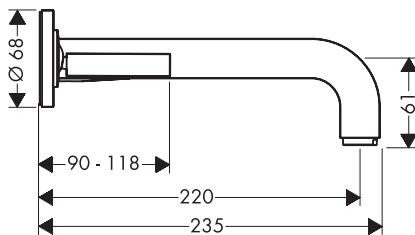
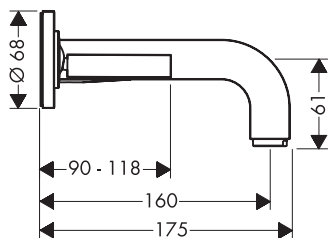

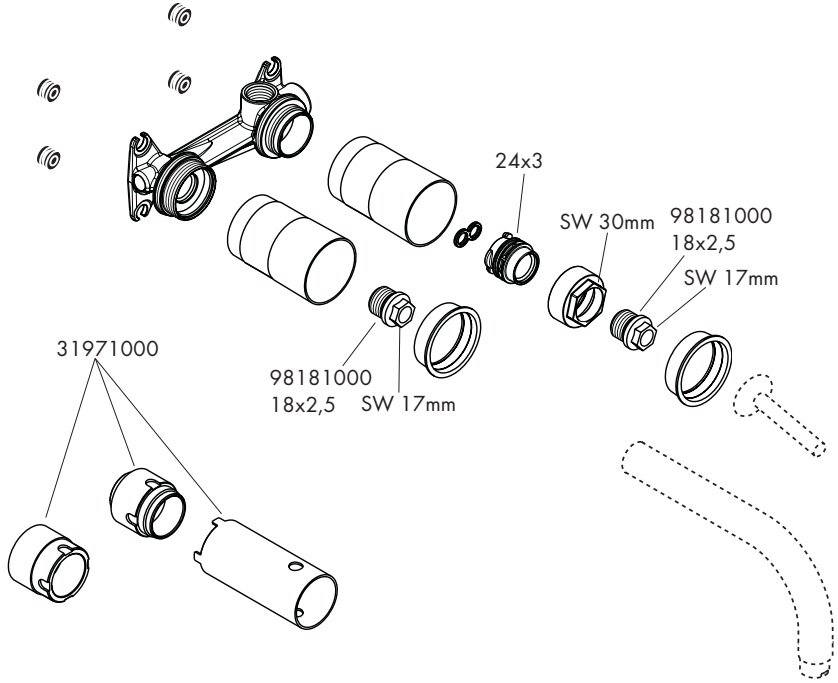

P-IX

DVGW

SVGW

ACS

WRAS

ETA

KIWA

13622180

 1.42/19221